

# New investment project in Alanya, Konakly district (036398)



**290 000 € - 320 000 €**

- 🏠 Floor area**      **91 m<sup>2</sup>**
- 🏠 Number of rooms**      **2 bedrooms**
- 🪑 Furnitures**      **Partly**
- 🌊 To the beach:**      **300 m**
- 📍 Location:**      **Turkey, Alanya, Konakli**
- ✈️ To the airport:**      **60 km**

 To the city  
centre:

12 km

## Options

- ✓ Sea view
- ✓ Mountain view
- ✓ Balcony/ Terrace
- ✓ Swimming pool
- ✓ Residence permit
- ✓ Outdoor parking
- ✓ 0% installment
- ✓ Garden
- ✓ Playground
- ✓ Generator

## Description

We present a new investment project in Alanya, Konakly district. Rest and accommodation in the green area of Konakly is perfect for those who dream of a quiet, relaxed pastime away from the noise of large cities.

It is in this cozy area that we offer a chic new residential complex consisting of 8 two-storey blocks - 4 to 5 apartments and 4 to 4 apartments, with 2 huge swimming pools and fenced territory. There are 36 apartments.

The project combines European quality of construction and elegant design, has an excellent infrastructure and a closed protected area.

Presented two-level apartment 2+1 duplex area of 91 sq.m. Each apartment has 2 bedrooms, a lounge with an American style kitchen, 2 bathrooms and 2 balconies. The price already includes complete finishing, built-in kitchen furniture and fully equipped bathrooms.

The residence will be located only 300 meters from the coast of the Mediterranean Sea and sandy beach.

Project infrastructure:

- Outdoor pools
- Indoor pool
- Fitness
- Turkish bath
- Steam room
- Sauna
- Relaxation area
- Restaurant
- Children's playground
- Transfer to the beach

Start of construction of the complex - 01.06.2022.

Completion of construction - 30.09.2024.

**Information updated 12.08.2024**

## Photo gallery



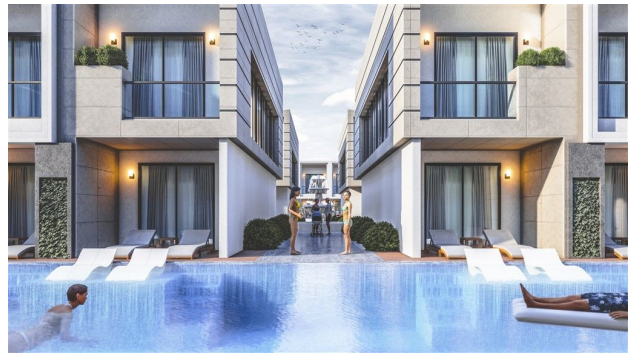
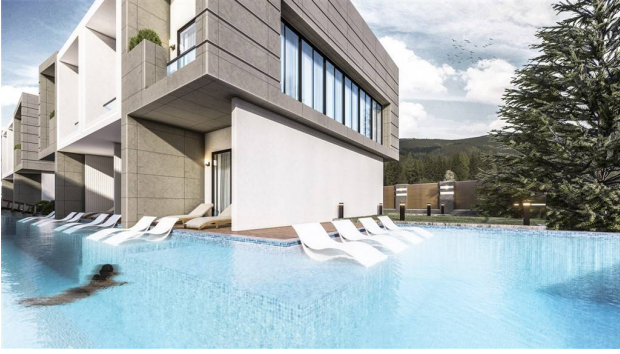



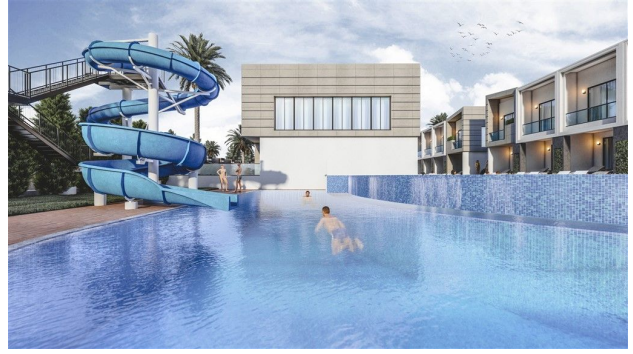
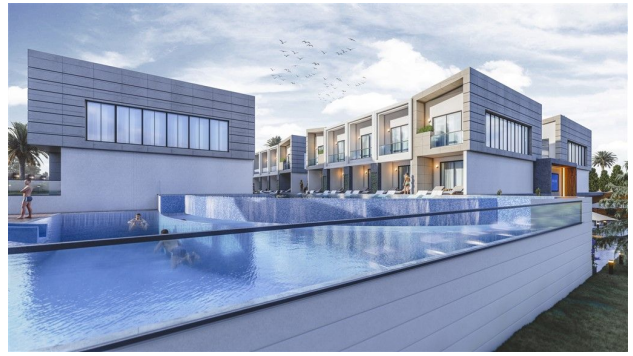

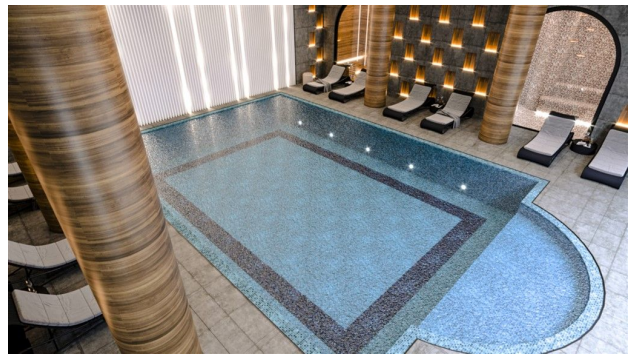
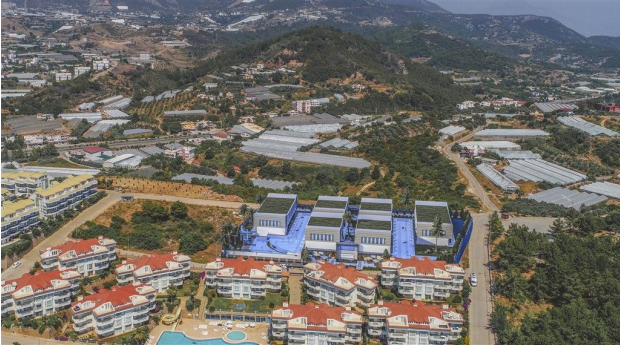

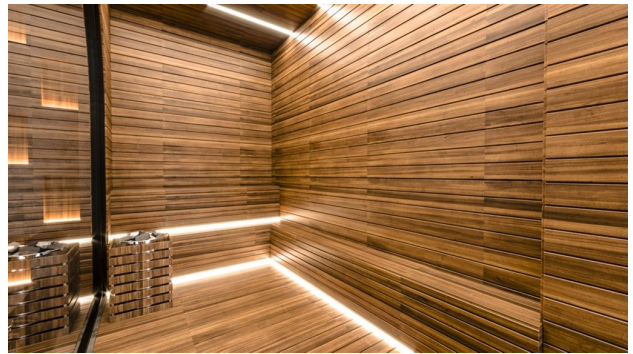
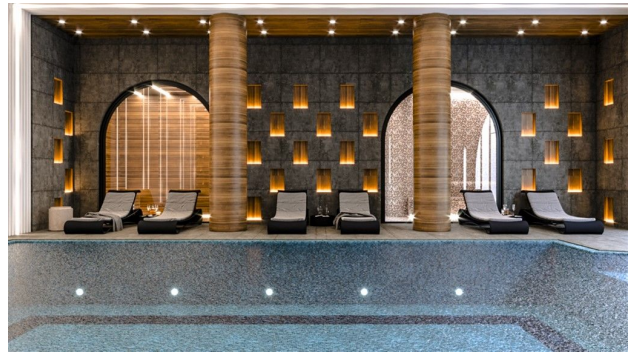
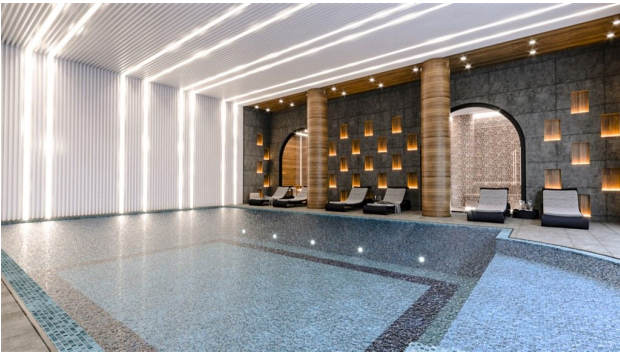
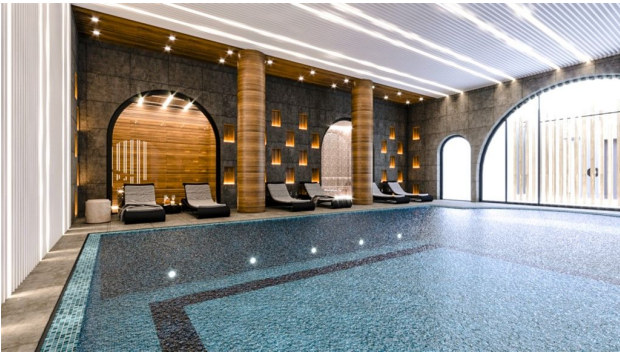



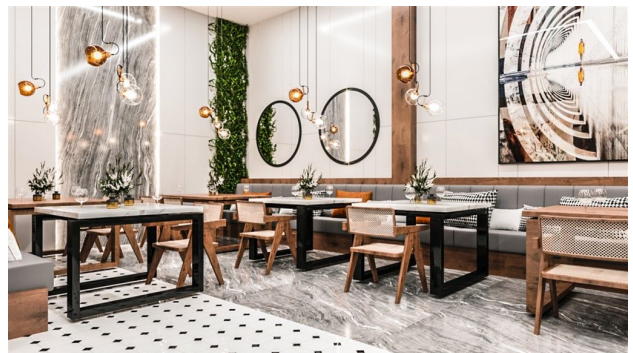
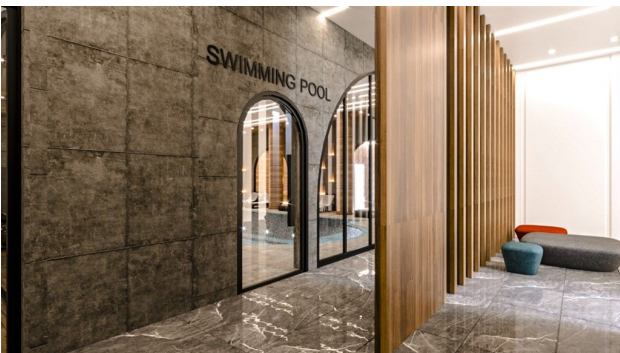
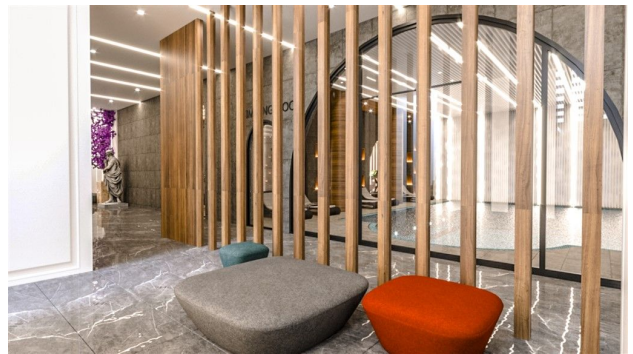
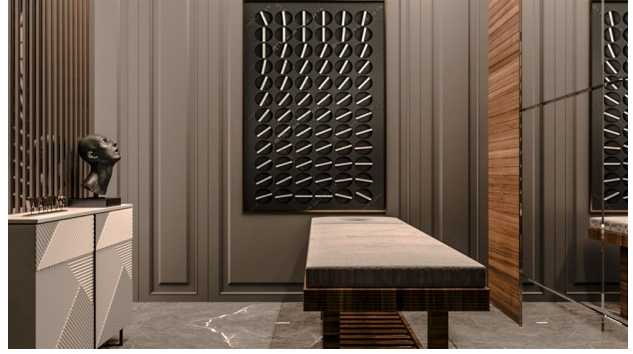
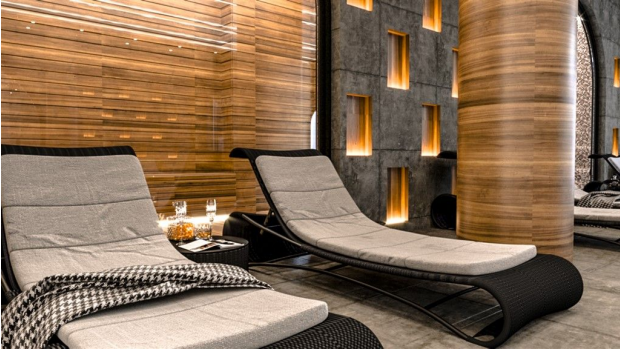
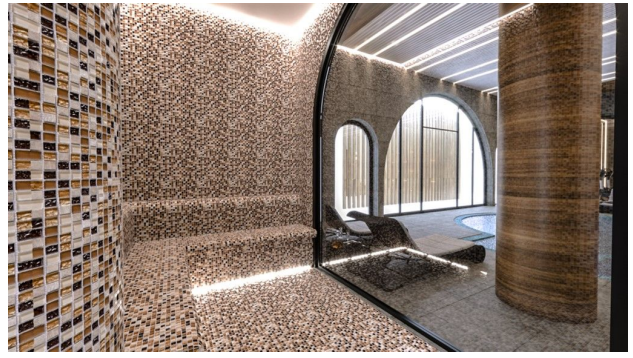
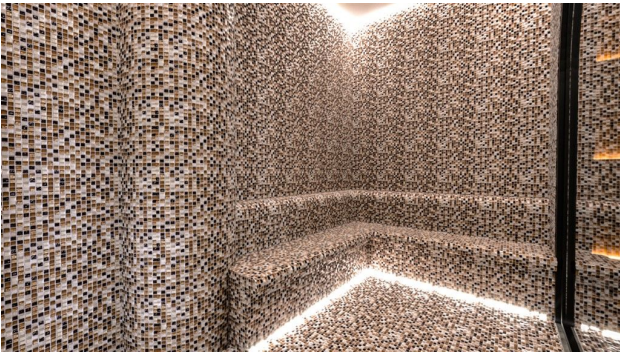

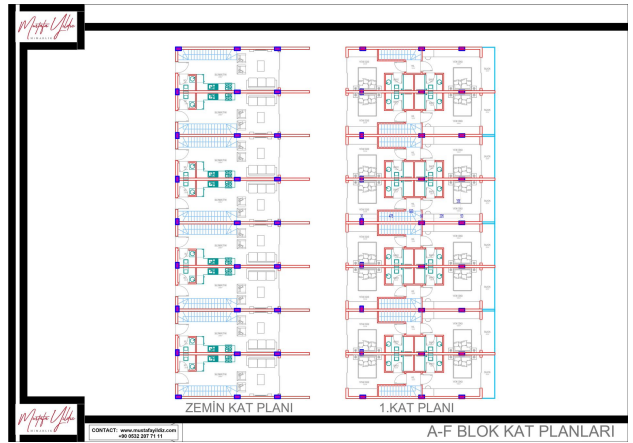
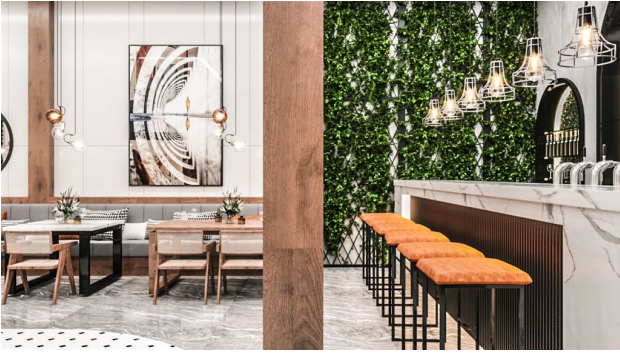

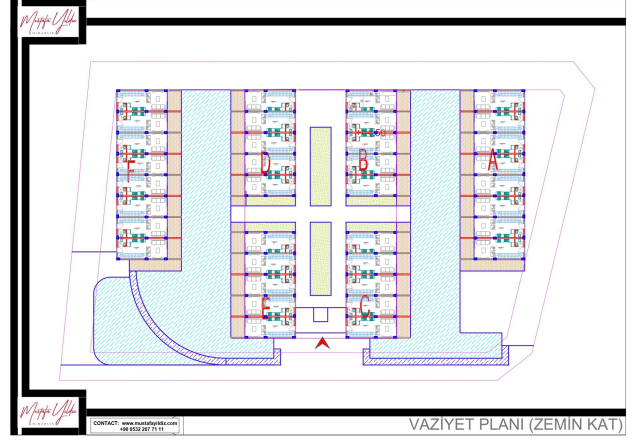
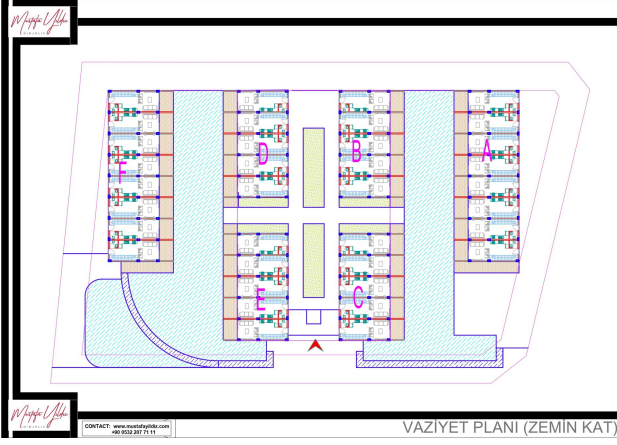
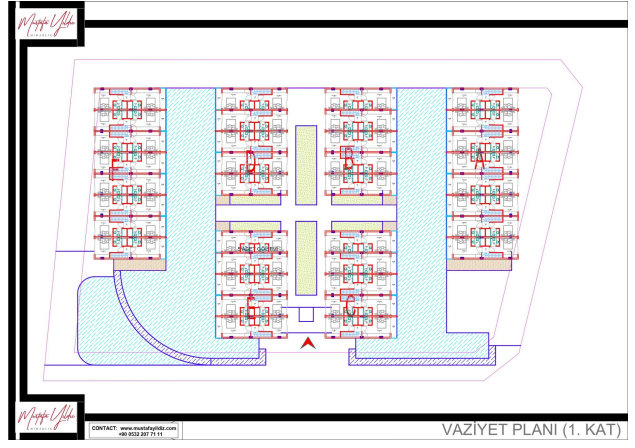
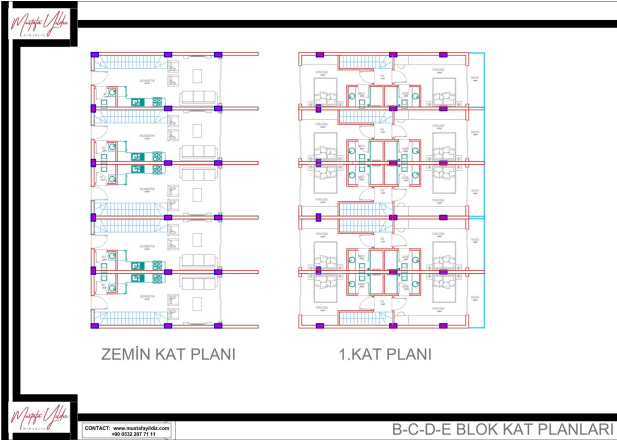

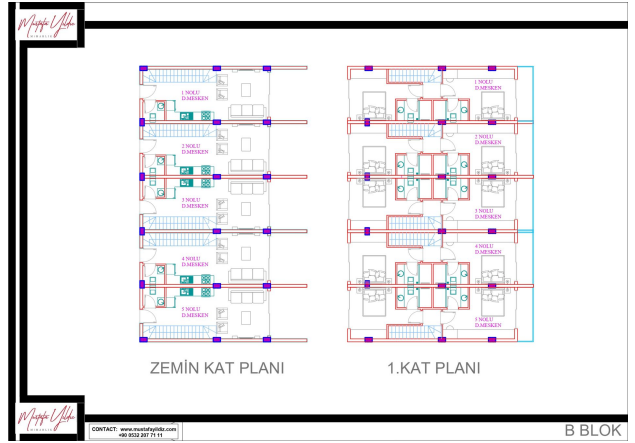
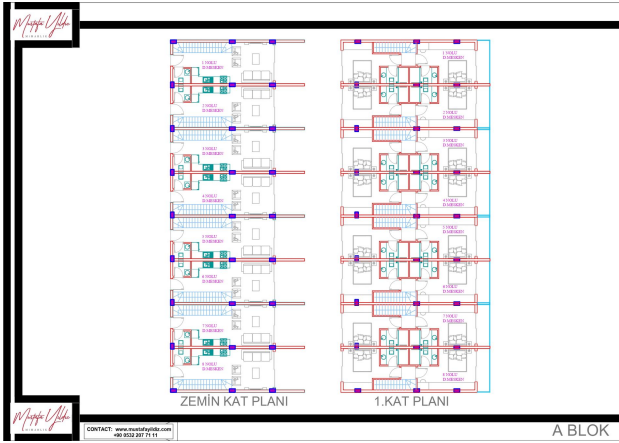
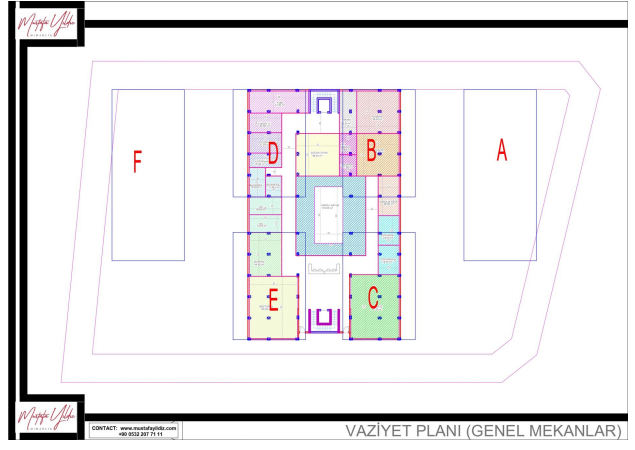
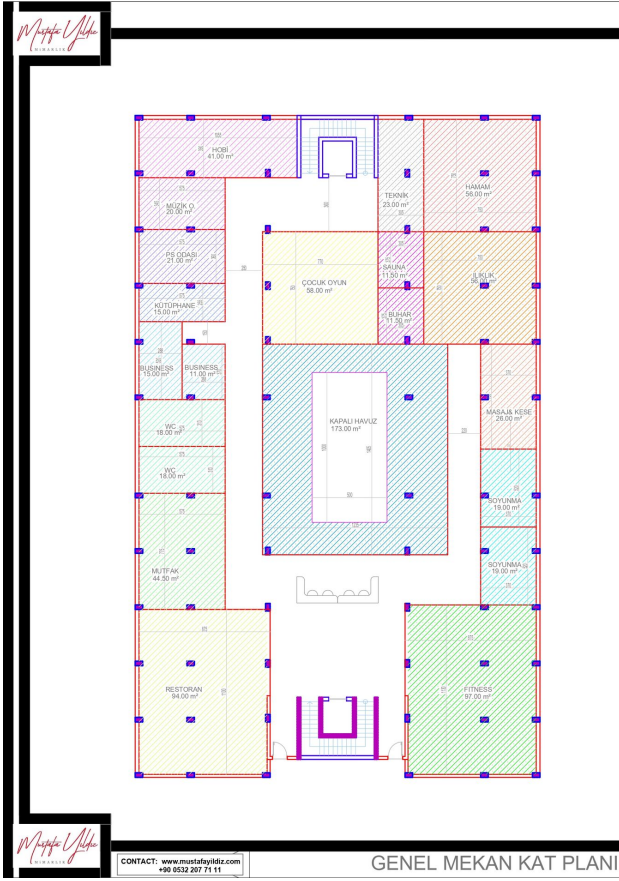

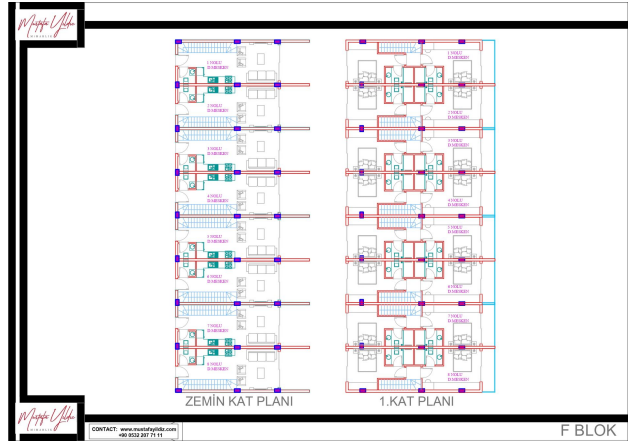
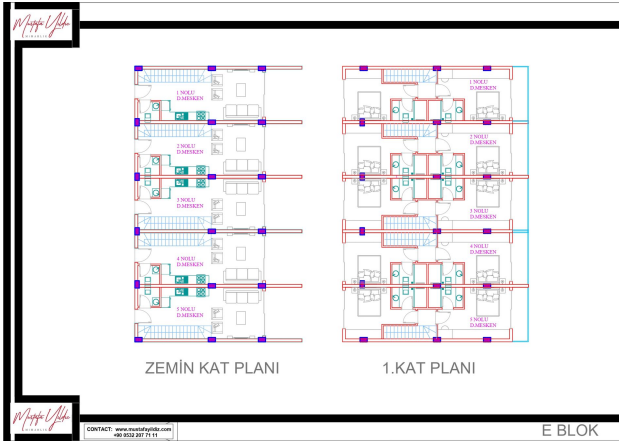
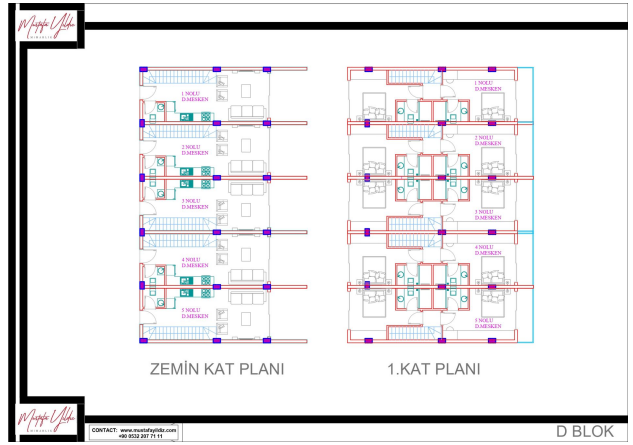
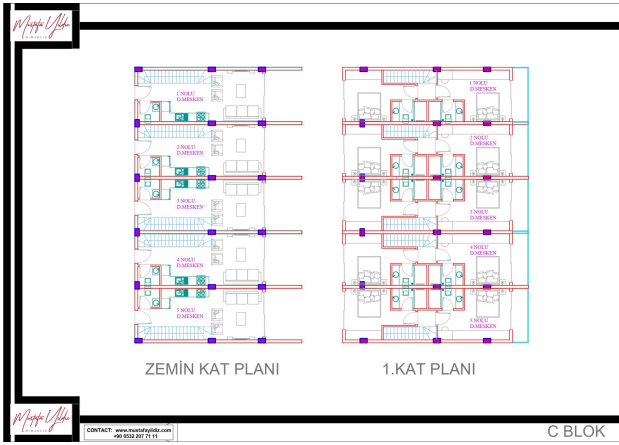

Scan the QR code to open the original page